

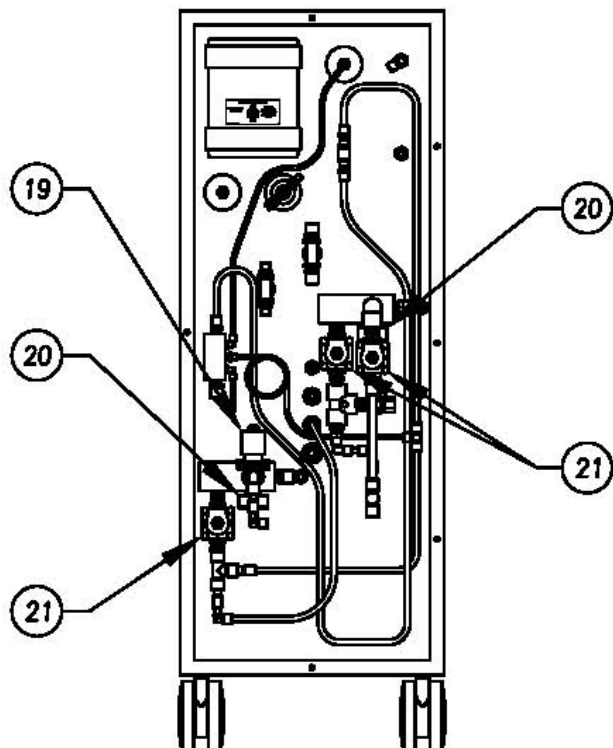

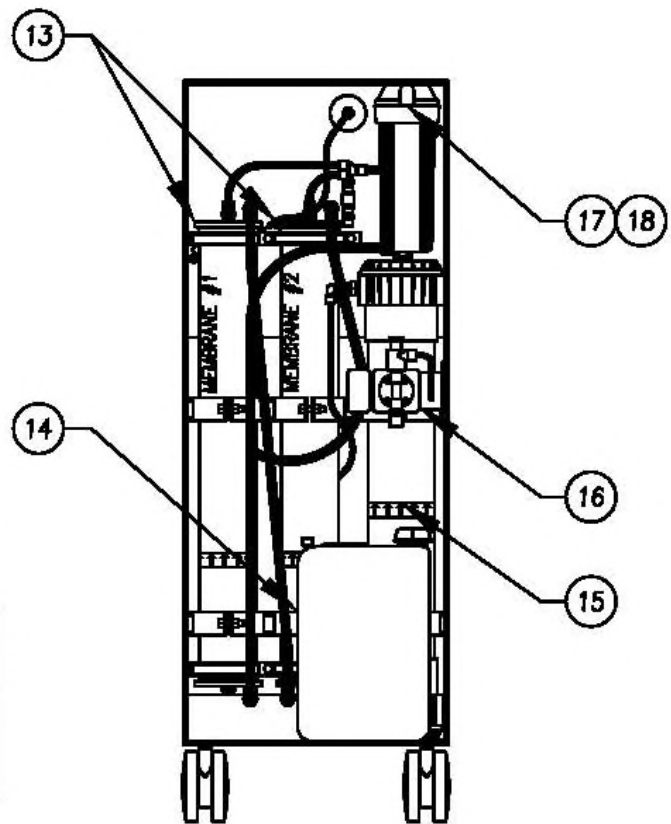

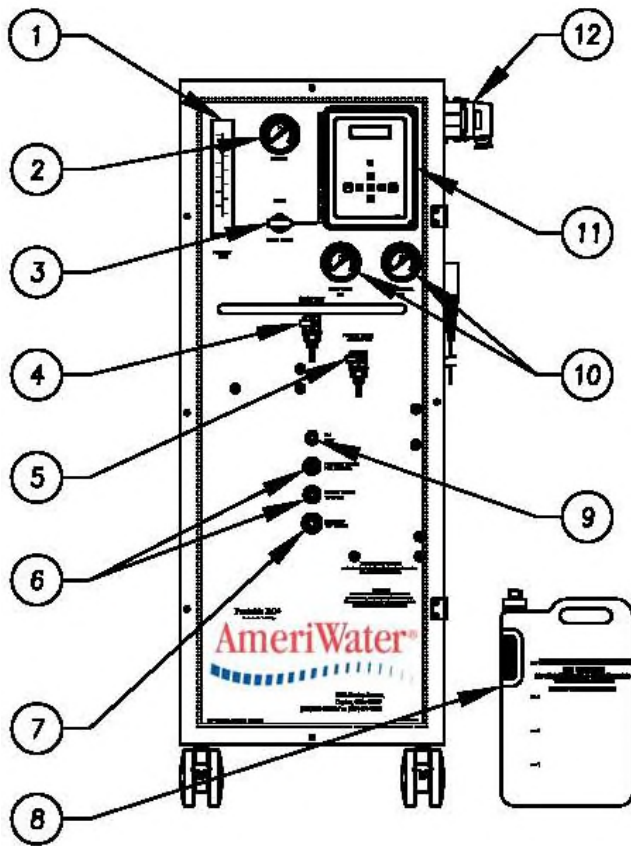







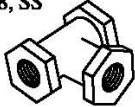
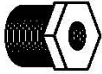
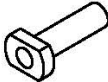









# SECTION 11 - MRO2 SPARE PARTS LIST

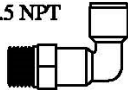
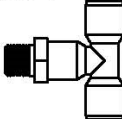
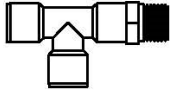
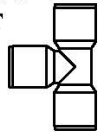
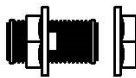
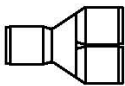
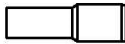

NO	DESCRIPTION	PART #
1	FLOW METER	41530606
2	PUMP PRESSURE GAUGE	43530714
3	FLUSH VALVE	04-5001
4	CHLORAMINE TEST PORT	041003
5	PRODUCT TEST PORT	041004
6	3/8 INCH BULKHEAD	10-L277
7	1/2 INCH BULKHEAD	10-L278
8	PAA BOTTLE ASSEMBLY	0185-0020
9	PAA CONNECTOR	16-0042
10	PREFILTER GAUGES	43-0012
11	CONTROLLER ASSEMBLY	R69446010
12	SIDE ENTRY HOOD	0167-0014
13	MEMBRANE ASSEMBLY	R124-0047
13	MEMBRANE ONLY	R22-4026
14	PT401 (4 GALLONS/CASE)	95810125
15	RO PUMP ASSEMBLY	R80-0055
16	PT401 PUMP (OPTIONAL)	R84-0002
17	FILTER HOUSING (10")	21-0033
18	O-RING, FILTER (10")	21530234
19	SOLENOID VALVE NO	R59-0006
20	CONDUCTIVITY SENSOR	69446017
21	SOLENOID VALVE NC	R59-0002

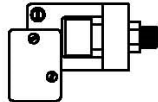
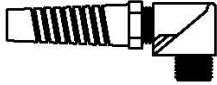
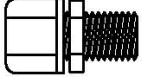
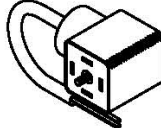
<b>HOSES</b> INLET P/N: 0112-0030 PRODUCT P/N: 0112-0031 REJECT P/N: 0112-0032 	<b>GARDEN HOSE FEMALE ADAPTER KIT: NUT, WASHER, .5" BARB, P/N: 0112-0046</b> 	<b>NIPPLE</b> P/N: 046531105, 0.5 X CL, PP P/N: 044531107, 0.5 X 1.5, SS 	<b>TEE, THREAD, NPT</b> P/N: 044730135, .25, SS P/N: 044531506, .38, SS 
<b>BUSHING</b> P/N: 046531845 .75 MPT x .5 FPT P/N: 046531849 .75 MPT X .38 FPT P/N: 046530201 .5 MPT X .25 FPT 	<b>PLUG</b> P/N:10520898 3/8 STEM P/N:10521106 1/2 STEM 	<b>BARB CONNECTORS</b> .38 STEM x .38 BARB P/N: 10521026 .5 STEM X .5 BARB P/N: 10521011 	<b>CHECK VALVE, .5MPT</b> P/N:10720102 
<b>SS TUBE INSERT</b> 3/8" P/N: 10-0018 1/2" P/N: 10-0019 	<b>CON, MALE, T X NPT, SS</b> P/N: 10-0021 .38 T X .5 NPT 	<b>ELBOW, MALE, T X NPT, SS</b> P/N: 10-0023 .5 T X .5 NPT 	<b>ELBOW, FEMALE, T X NPT, SS</b> P/N: 10-0025 .5 T X .5 NPT 
<b>REPLACEMENT NUTS, SS</b> 10-0027 .38" NUT 10-0028 .5" NUT 	<b>REPLACEMENT FERRULES, SS</b> 10-0030 .38" FERRULE SET 10-0031 .5" FERRULE SET FITTING SIDE  NUT SIDE  SOLD IN SETS OF 10 ONLY	<b>MALE QUICK CONNECTORS</b> P/N: 10-L002 .25 T X .25 NPT P/N: 10-L003 .38 T X .25 NPT P/N: 10-L005 .5 T X .38 NPT P/N: 10-L006 .5 T X .5 NPT 	<b>FEMALE QUICK CONNECTOR</b> P/N: 10-L026 .25 T X .25 NPT P/N: 10-L027 .38 T X .38 NPT 
<b>FIXED EL, TUBE X MALE NPT</b> P/N: 10-L051 .25 T X .25 NPT 	<b>SWIVEL EL, TUBE X NPT</b> P/N: 10-L102 .25 T X .25 NPT P/N: 10-L105 .38 T X .38 NPT P/N: 10-L107 .5 T X .5 NPT 	<b>SWIVEL BR TEE, TUBE X NPT</b> P/N: 10-L132 .5 T X .5 NPT 	<b>SWIVEL RUN TEE, TUBE X NPT</b> P/N: 10-L157 .5 T X .5 NPT 
<b>UNION TEE</b> P/N: 10-L253 .38 T X .25 T P/N: 10-L254 .5 T X .5 T 	<b>QUICK CONNECT BULKHEAD</b> P/N: 10-L277 3/8" P/N: 10-L278 1/2" 	<b>2-WAY DIVIDER</b> P/N: 10-L302 3/8" 	<b>REDUCER</b> P/N: 10-L352 3/8" X 1/4" P/N: 10-L353 1/2" X 3/8" 
<b>PLUG-IN EL, STEM x TUBE</b> P/N: 10-L377 3/8" P/N: 10-L378 1/2" 	<b>FILTER WRENCH</b> P/N: 21675184 	<b>CHECK VALVE 3/8" TUBE X TUBE</b> P/N: 55-0011 	<b>INLET PRESSURE SWITCH</b> P/N: R65511105 SET AT 3 PSI 
<b>STRAIN RELIEF</b> P/N:66510619 	<b>STRAIN RELIEF FITTING P/N:66510621</b> 3 HOLE BUSHING PN- 66-0041 	<b>SOLENOID WIRE HARNESS</b> P/N: 66932109 	<b>CASTER 100MM</b> P/N: 94-0013 W/BRAKE P/N: 94-0014 W/O BRAKE 

**ROUTINE REPLACEMENT ITEMS (NON-DURABLE COMPONENTS)**

<b>PART #</b>	<b>DESCRIPTION</b>
20-1011	1 Micron Particulate Filter
95810125	PT401 Antiscalant, (4) 1 Gallon Containers
95810126	PT401 Antiscalant for High pH WATER, (4) 1 Gallon Containers
R22-4026	RO+ Membrane
95-0006	Peracidin (2) quart containers
95-0007	Peracidin (4) quart containers
000-095-0001	Kit,Biotrol+,5 Gal Container+Powder,Portable MRO
97HP20401	Test Strips Peracid Test (6 Bottles of 100 Strips each) For Measuring High Range Paracetic Acid
97PX20501	Test Strips Renal Check (6 Bottles of 100 Strips each) For Measuring Residual Peroxide
97PH20901	Test Strips pH (6 Bottles of 100 Strips each) For Measuring pH/Water/Acid,Base/Bicarbonate/Dialysate
97RC22101	WaterCheck RC (6 Bottles of 100 Strips each) For Measuring Residual Chlorine
97CM20201	WaterCheck 2 (6 Bottles of 100 Strips each) For Measuring Low Level Chlorine/Chloramine
LAL	LAL Endotoxin Testing, Exact results in just a few days
AAMI	AAMI Chemical Analysis, Results within one week

\*Call AmeriWater or your AmeriWater distributor for pricing.